

1 IMPLANTAÇÃO
ESCALA 1:1000

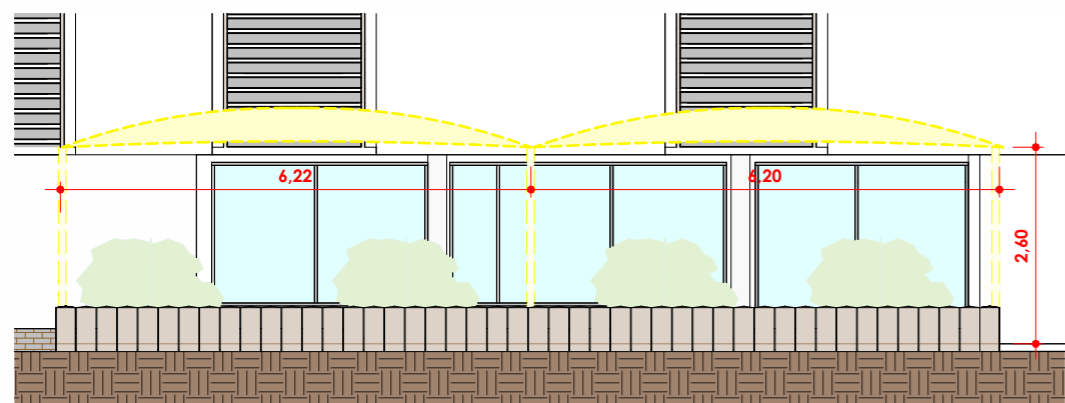

2 VISTA FRONTAL
ESCALA 1:100

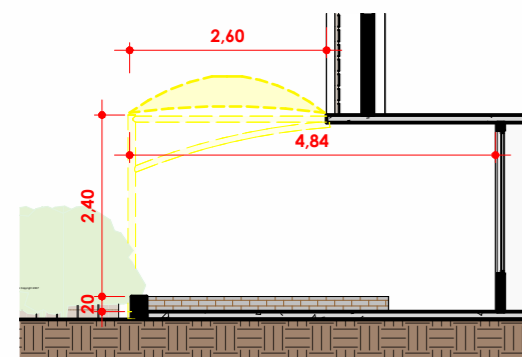

3 CORTE A
ESCALA 1:100

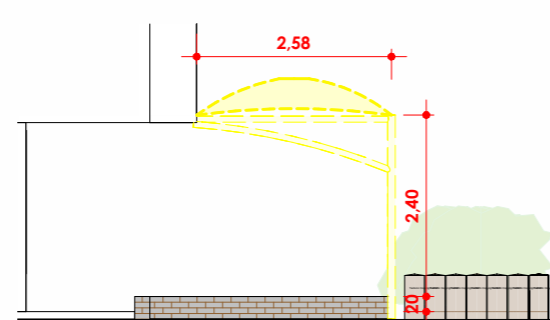

4 VISTA LATERAL
ESCALA 1:100

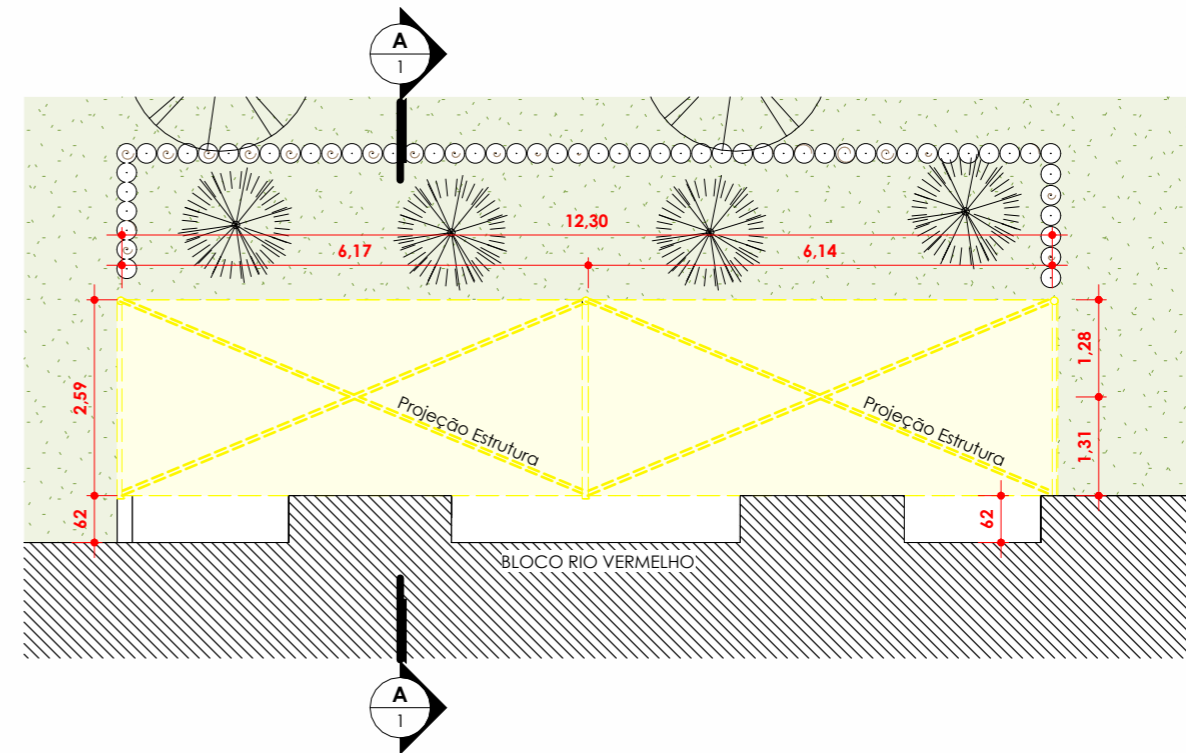

5 PLANTA DE LOCAÇÃO E COBERTURA
ESCALA 1:100



6 PERSPECTIVA
ESCALA

Tabela de telhado	
Tipo	Área
Sombreador Demolido	33,02 m ²

OBSERVAÇÃO: CONFERIR MEDIDAS NO LOCAL

DEMOLIÇÃO DE COBERTURA SOMBREADOR		
Tipo	Área	
Sombreador Demolido	33,02 m ²	

CONTROLE DE APRESENTAÇÃO DE PROJETOS		
DATA	NOME	ASSINATURA

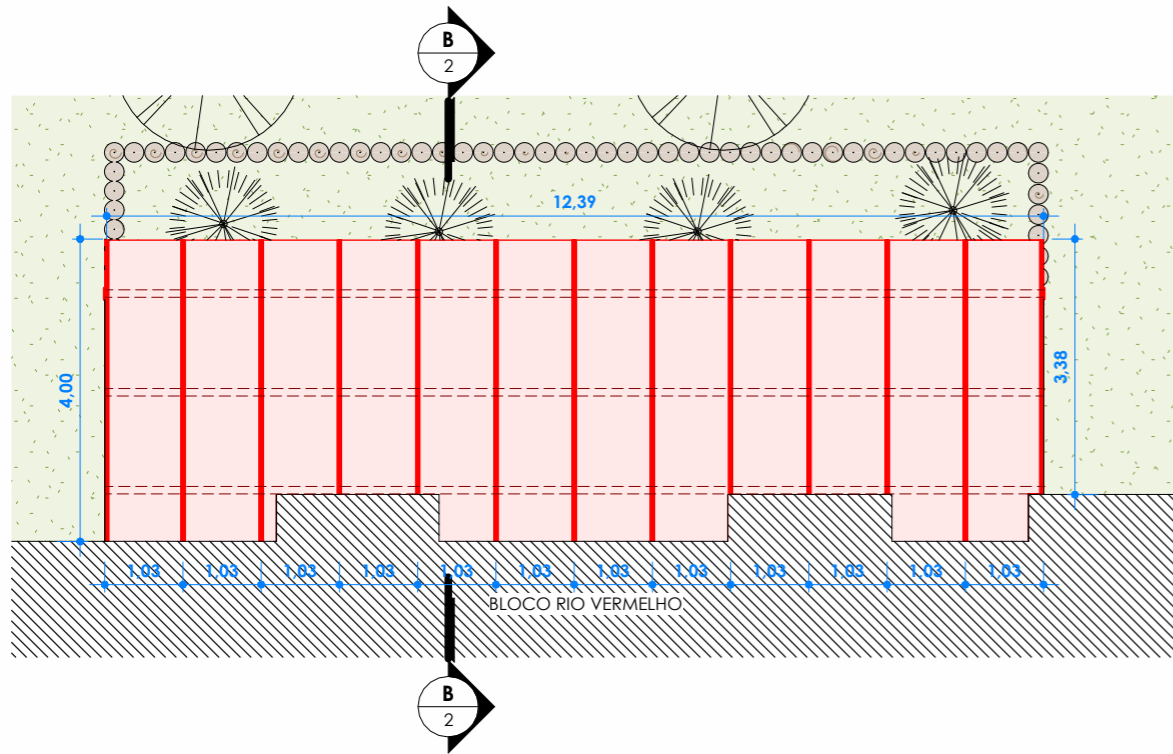

1 PLANTA DE LOCAÇÃO E COBERTURA
ESCALA 1 : 100

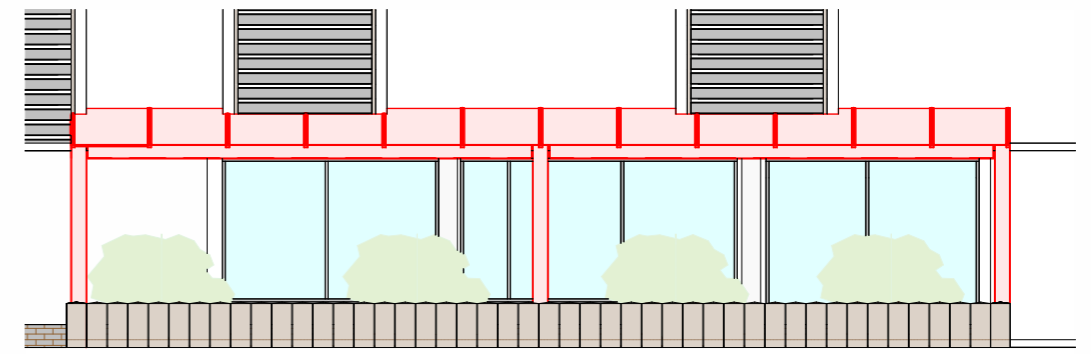

2 VISTA FRONTAL
ESCALA 1 : 100

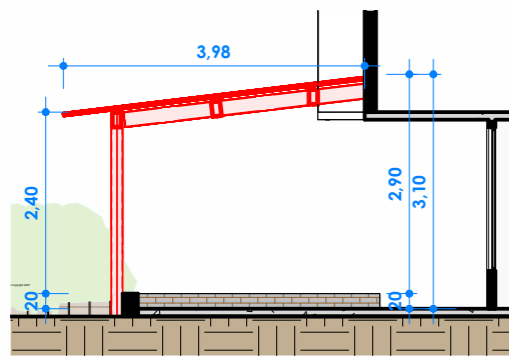

3 CORTE B
ESCALA 1 : 100

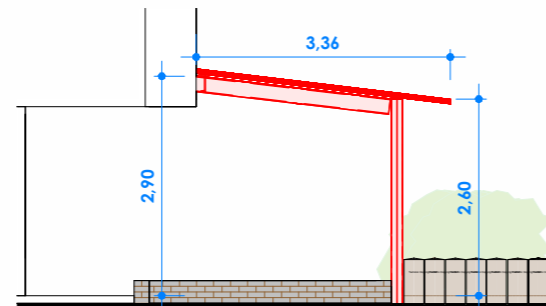

4 VISTA LATERAL
ESCALA 1 : 100

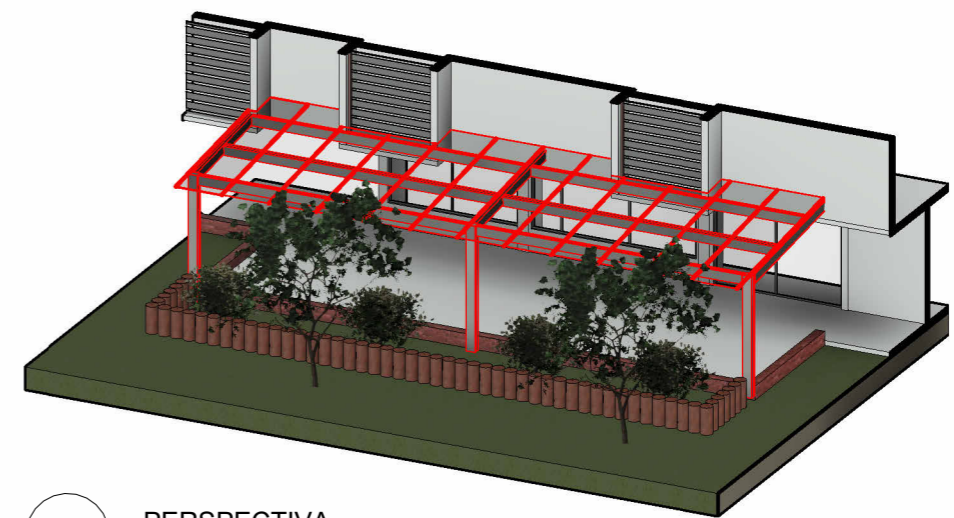

5 PERSPECTIVA
ESCALA

DEMOLIÇÃO DE COBERTURA SOMBREADOR	
Tipo	Área
Sombreador Demolido	33,02 m ²

CONTROLE DE APRESENTAÇÃO DE PROJETOS		
DATA	NOME	ASSINATURA

OBSERVAÇÃO: CONFERIR MEDIDAS NO LOCAL



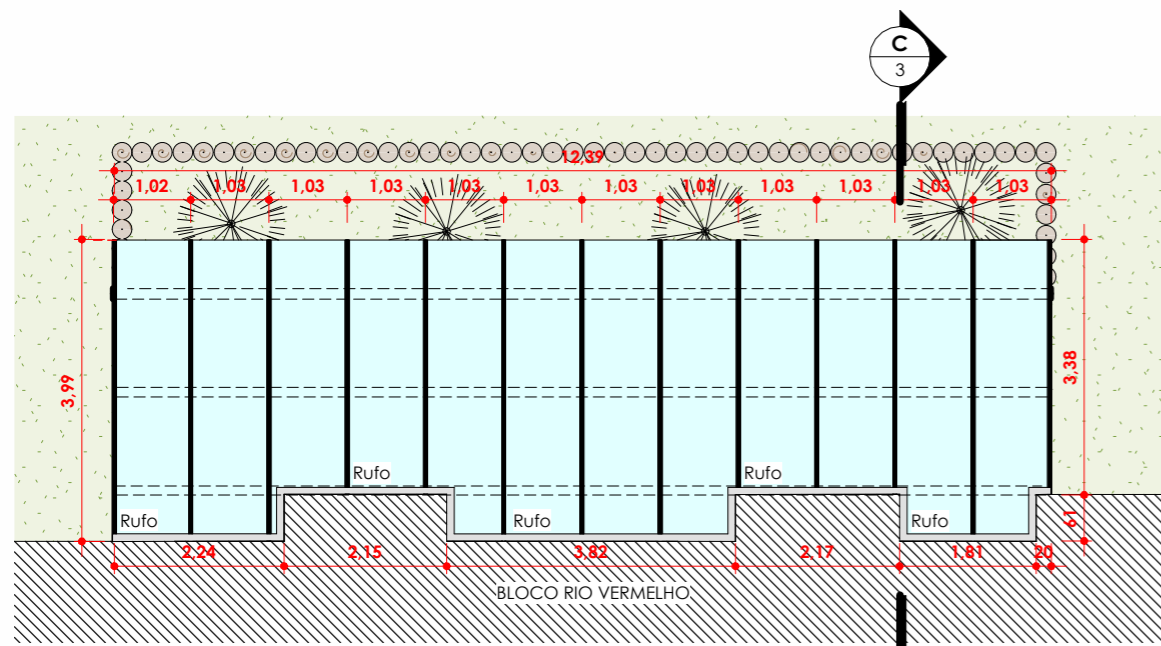

1 PLANTA DE LOCAÇÃO E COBERTURA
ESCALA 1 : 100

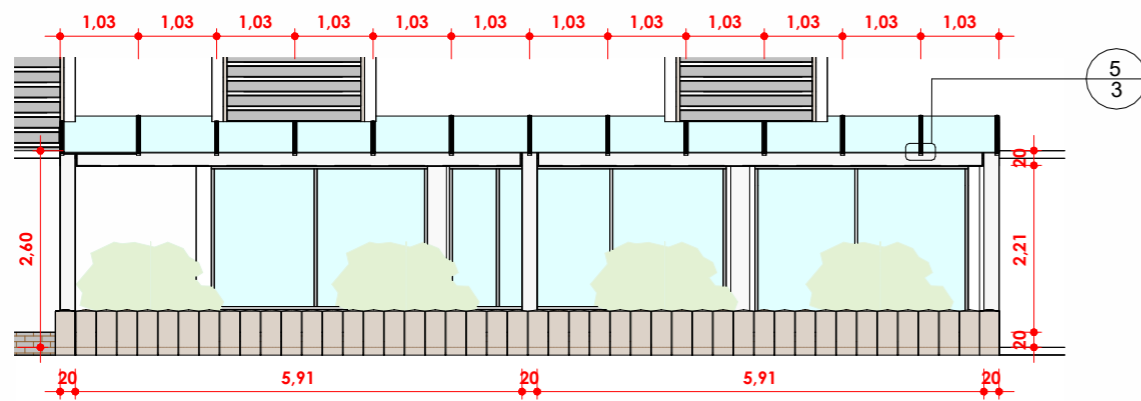

2 VISTA FRONTAL
ESCALA 1 : 100

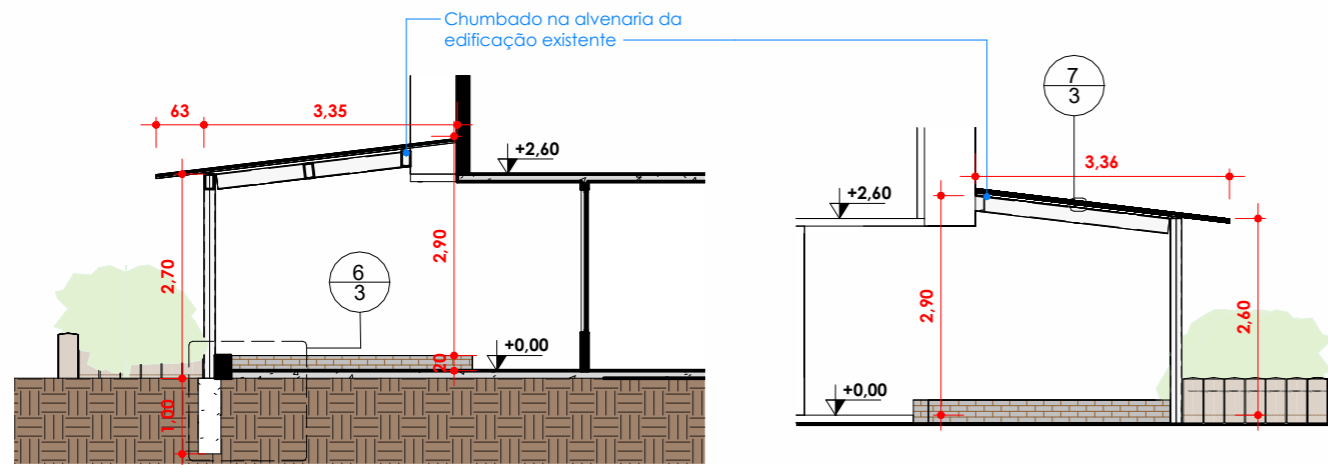

3 CORTE C
ESCALA 1 : 100

4 VISTA LATERAL
ESCALA 1 : 100

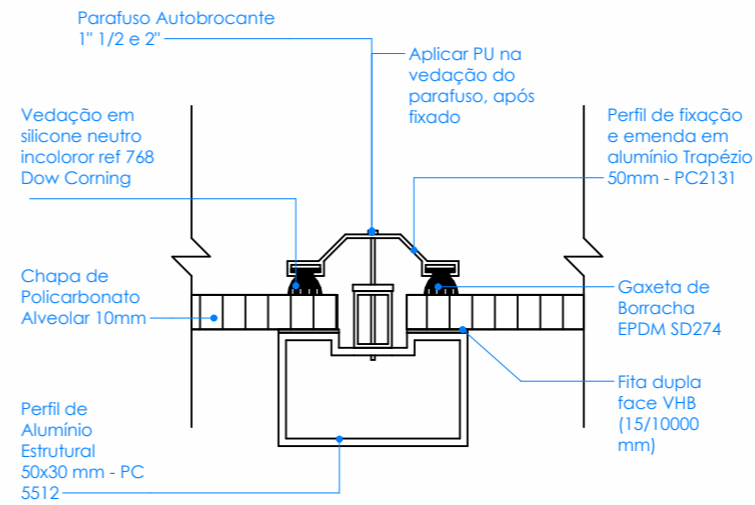

5 DETALHE JUNTA ALUMÍNIO
ESCALA 1 : 50

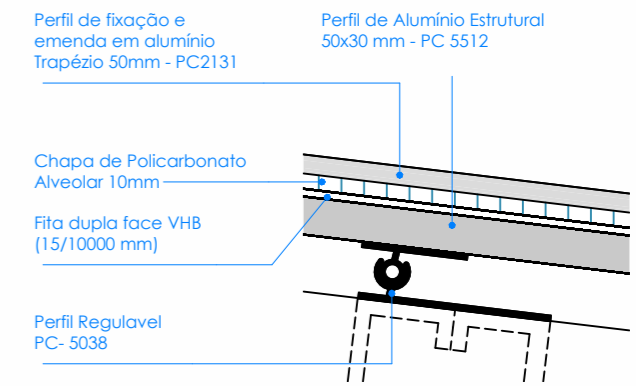

7 DETALHE PERFIL REGULÁVEL
ESCALA 1 : 5

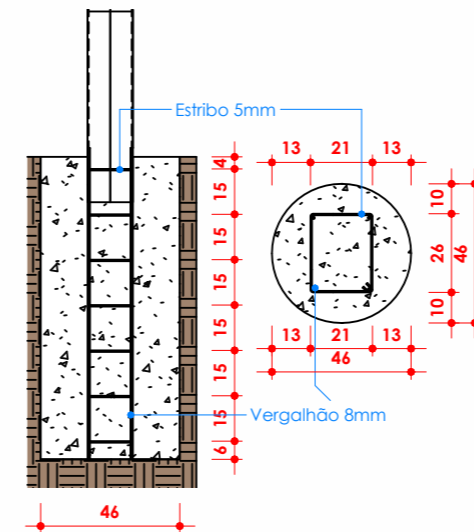

6 DETALHE ESTACA ESTRUTURAL
ESCALA 1 : 25

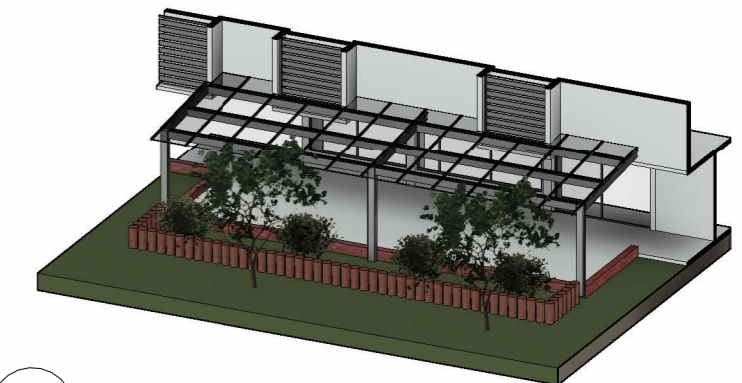

8 PERSPECTIVA
ESCALA

Perfil de fixação e emenda em alumínio Trapézio 50mm - PC2131	48,4 m
Perfil de Alumínio Estrutural 50x30 mm - PC 5512	48,4 m
Gaxeta de Borracha EPDM SD274	96,8 m
Fita dupla face VHB (15/10000 mm)	96,8 m
Vedação em silicone neutro incolor ref 768 Dow Corning	96,8 m
Perfil Regulável PC- 5038	37,20m²
Chapa de Policarbonato Alveolar 10mm	46,81m²
Parafuso Autobrocante 1" 1/2 e 2" + Anel de Vedação	162 Un

CONTROLE DE APRESENTAÇÃO DE PROJETOS		
DATA	NOME	ASSINATURA

OBSERVAÇÃO: CONFERIR MEDIDAS NO LOCAL